



Marking, coding and systems solutions

Pharmaceutical and Medical Devices



by  VIDEOJET.



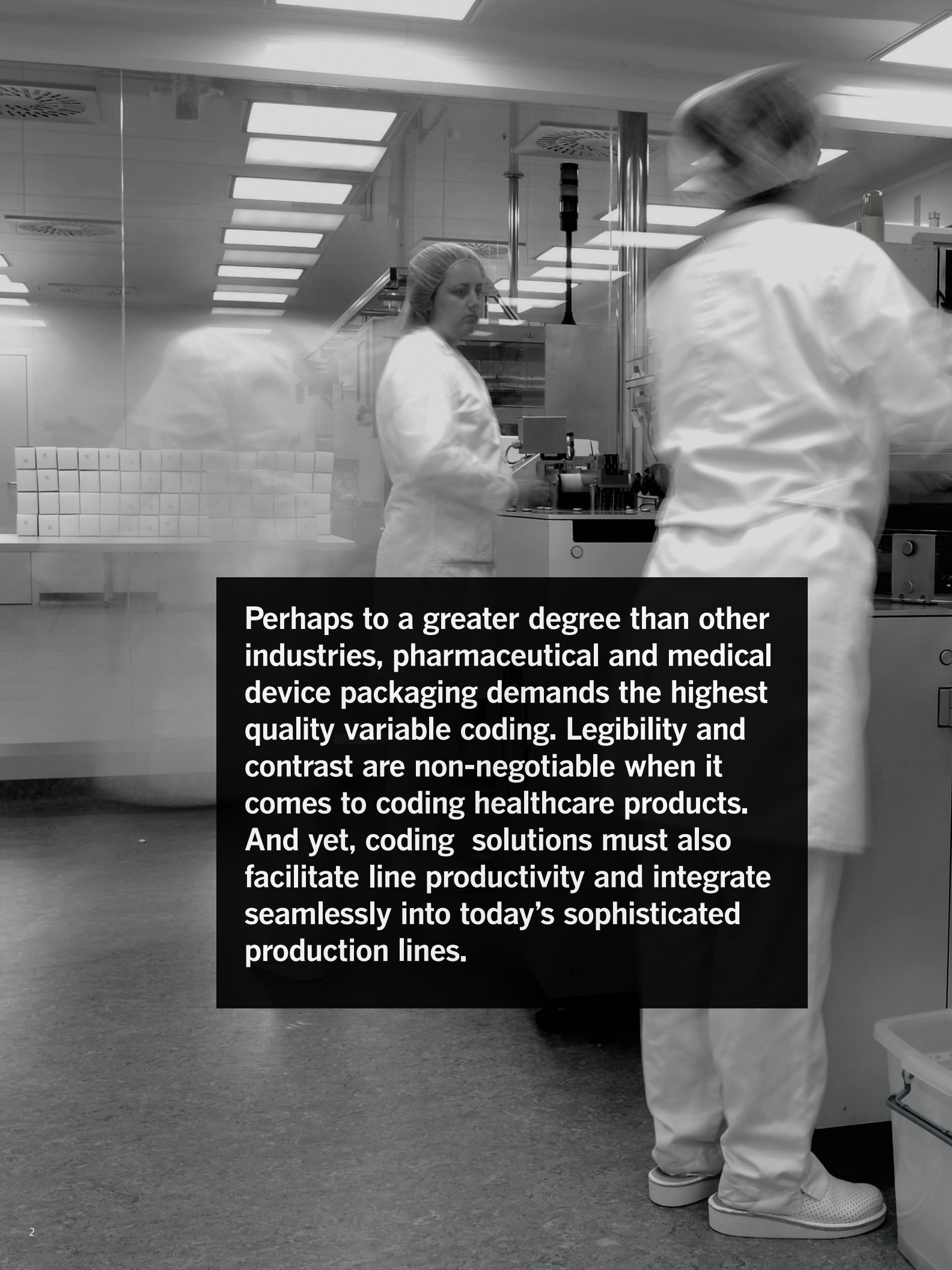

Perhaps to a greater degree than other industries, pharmaceutical and medical device packaging demands the highest quality variable coding. Legibility and contrast are non-negotiable when it comes to coding healthcare products. And yet, coding solutions must also facilitate line productivity and integrate seamlessly into today's sophisticated production lines.



Protect your products and your consumers.

Addressing regulatory requirements across a diverse array of substrates requires a partner with the technology and expertise to help meet your project requirements.

Our dedicated Pharmaceutical and OEM sales teams are ready to partner with you on your projects. With decades of experience, we're well-versed with industry standards and global regulations, making us the right partner for your coding technology needs.

Uptime advantage

With complex production schedules supporting global operations, you cannot afford coder related downtime. Our technology is designed to deliver optimal code quality while keeping your lines running.

Code Assurance

As serialization requirements continue to evolve, data management becomes more complex and critical. Our printers are designed to intelligently manage your data to get the right code, on the right product, time after time.

Built-in productivity

Videojet equipment integrates seamlessly into a wide array of pharmaceutical equipment, facilitating work flow to help meet your production goals.

Simple usability

Our solutions are easy to operate and require less maintenance due to industry-leading hardware and software innovation, designed with your packaging process in mind.

Expertise for seamless integration

Optimal coding solutions are part of a holistic approach to pharmaceutical manufacturing, with the printer playing a small but integral role in addressing industry regulations. While physical integration remains a vital consideration, demand is increasing for equipment that can handle more complex data management responsibilities without compromising product safety or legislative compliance.

Videojet solutions are designed with these requirements in mind, helping create serialized, human- and machine-readable codes to address pharmaceutical regulations. In addition, Videojet service and technical support teams help ensure that the installation is done right and provides support throughout the life of the printer.

Coding technologies

Blister/Cartoner

Coding may occur in several locations, either integrated into the cartoner itself or on the outfeed conveyor. Printing may also occur upstream of the cartoner on the primary pack as required.

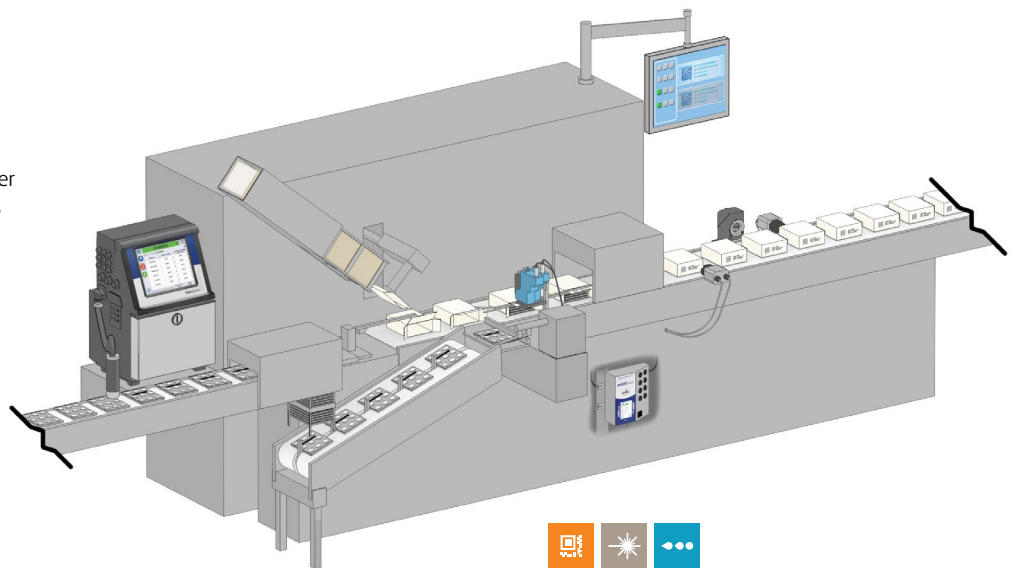

Laser Marking Systems

A beam of infrared light focused and steered with a series of carefully controlled small mirrors to create marks where the heat of the beam interacts with the packaging surface.



Thermal Inkjet (TIJ)

Ink-based, non-contact printing using heat and surface tension to move ink onto a package surface. Generally used to print 2D DataMatrix and other bar codes.



Continuous Inkjet (CIJ)

Fluid based, non-contact printing of up to five lines of text, linear and 2D bar codes, or graphics, printed on a variety of packaging types via traversing systems.



Thermal Transfer Overprinting (TTO)

A digitally controlled printhead precisely melts ink from a ribbon directly onto flexible films to provide high resolution, real-time prints



Large Character Marking (LCM)

Ink-based, non-contact printing of tall codes, including alphanumeric logos, and bar codes in large sizes primarily for cases



Label Printer Applicator (LPA)

Prints and places labels of various sizes on multiple package types

Coding technologies for your packaging type:

Printing application	TIJ	Laser	CIJ	TTO	LPA	LCM
Parenterals		✓	✓			
Blister packs	✓	✓	✓			
Cartons	✓	✓	✓			
Bottles and tubes		✓	✓			
Labels	✓	✓	✓	✓		
Flexible materials	✓			✓		
Cases	✓	✓			✓	✓

Checkweigher/Serialization module

Leveraging a checkweigher's precise material handling improves overall print and DataMatrix quality. The printer can generate its own codes or integrate into a broader serialization solution.

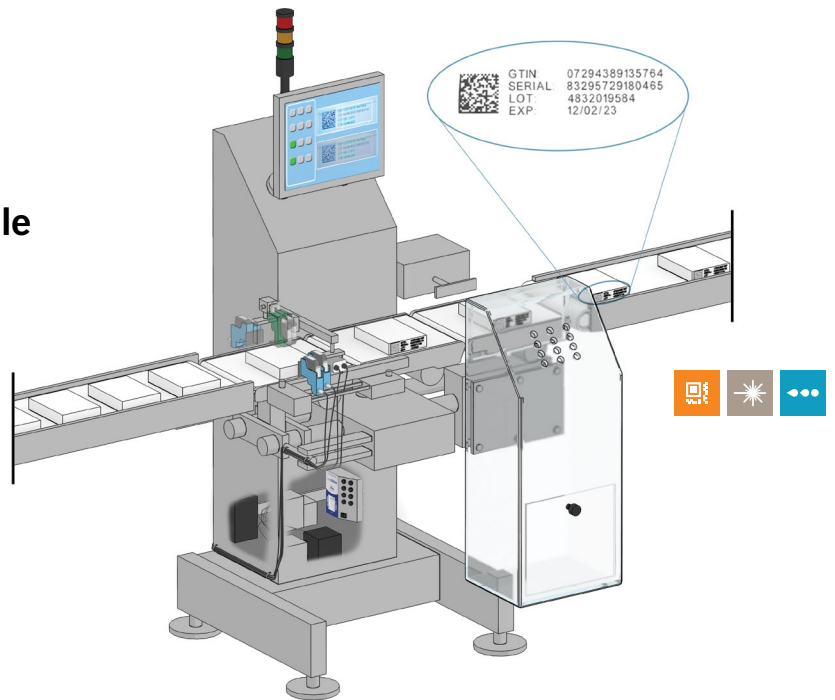

Side grip conveyor

Simple coder integration with a side grip conveyor allows for marking of either visible or covert codes on the top or bottom of pharmaceutical bottles. Downstream code verification can be easily accommodated while the bottle is engaged by the conveyor.

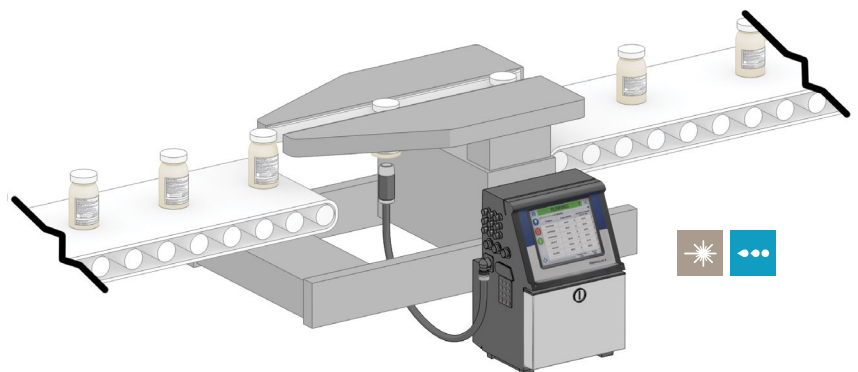

Bottle labeler

Precise control facilitates high quality alphanumeric and bar code printing on the label. Discrete codes can be applied to the bottles before or after label application.

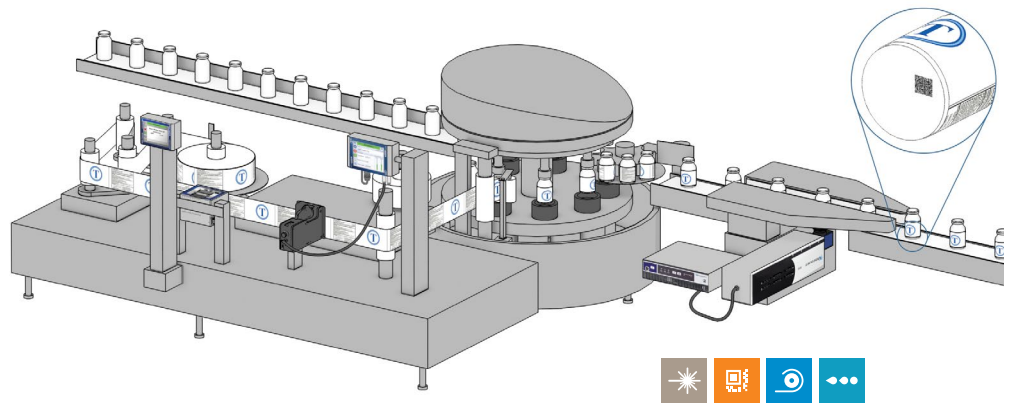

Starwheel

Consistent code accuracy is critical for internal traceability codes commonly placed on vials and ampules. The highly precise motion of the starwheel offers ideal material handling for this application.

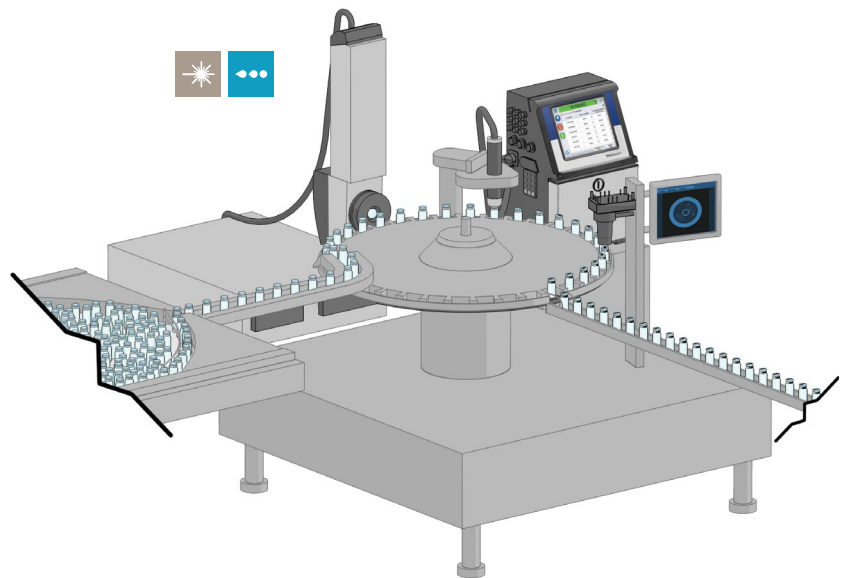

Thermoformer

Precise mechanical and controls integration helps ensure high quality marking on web-based materials, including blister lidding foils and other barrier films. Traversing solutions are available for thermal and continuous inkjet systems.

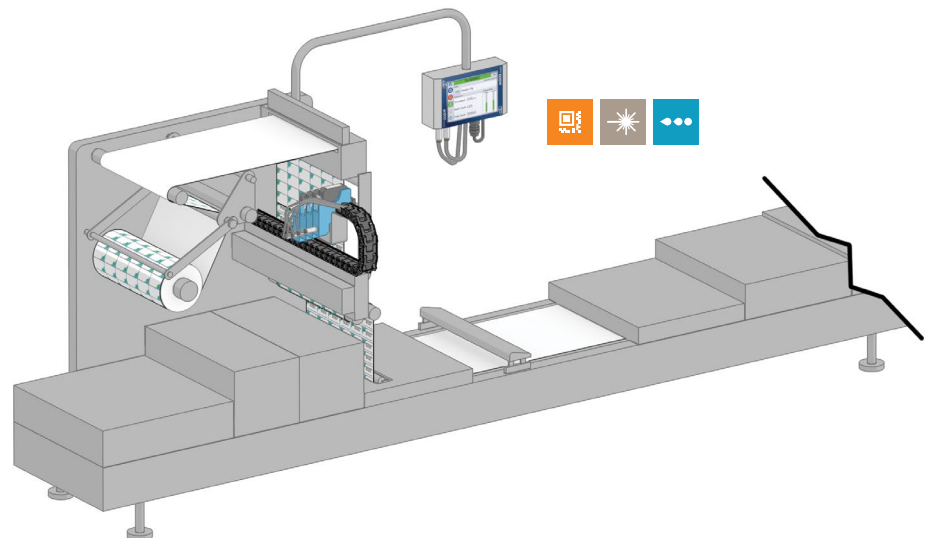

Parenterals

High resolution coding even in tight print windows

Whether being used for customer-facing information or bright stocking, coding injectable products is inherently challenging, given the small size and reduced radius of the packaging. Integrating the coding solution into OEM equipment provides improved product control, leading to higher quality human and machine readable codes. Videojet dedicated pharmaceutical and OEM specialists can help you select the correct solution for your application, whether it is plastic, glass or aluminum.



Continuous Inkjet (CIJ)

- Robust ink portfolio including autoclave resistant, visible and UV inks
- Videojet high resolution printers enable more content in small spaces such as flip tops, vial skirts, and syringes

Laser Marking Systems

- Creates high resolution 2D codes on aluminum vial caps for internal traceability
- Videojet offers multiple scan heads and precision optics to achieve desired mark quality

Blister packs

Coding solutions for the fast lanes

Blister coding requires keeping pace with rapid linear speeds while potentially coding multiple lanes simultaneously. Codes need to fit into small print areas and adhere throughout the life of the product. Videojet has the broadest portfolio of inkjet and laser printers to meet your blister coding needs.



Continuous Inkjet (CIJ)

- Wide range of both dark and light colored inks for maximum contrast
- CleanFlow™ printheads resist ink build-up, lessening maintenance requirements

Laser Marking Systems

- Creates permanent codes on a variety of blister materials
- Large marking windows maximize engagement time for coding multiple lanes simultaneously

Thermal Inkjet (TIJ)

- Four distinct printhead models facilitate integration into blister packing equipment
- Patented Black Solvent ink is purpose-built for blister foil applications

Cartons

Unlock track and trace capabilities

As the most common saleable unit for pharmaceutical and medical products, carton coding is critical for track and trace initiatives. Global regulations require up to 4 lines of text and a 2D bar code, but code quality and line speeds cannot be compromised. Videojet solutions can help you meet your regulatory requirements without compromising code quality or throughput.



Thermal Inkjet (TIJ)

- Prints complex, detailed codes at up to 600 x 600 dpi
- Wolke m600 oem provides secure, ultra-fast processing of up to 20 records per second, including 2D DataMatrix



Laser Marking Systems

- Permanent coding solution with virtually no consumables
- Videojet's 32 standard beam delivery options facilitates integration, helping create the best possible code quality



Continuous Inkjet (CIJ)

- Adheres to virtually all common carton materials, including non-porous and water-resistant coatings
- Smart Cartridge™ fluid delivery virtually eliminates spills

Bottles and tubes

Innovative solutions designed with your challenges in mind

Successful bottle coding is defined by the adherence, contrast, and permanence of the applied code. Achieving these characteristics relies on pairing the right printing technology with sound integration. Videojet has the technology and the expertise to achieve your coding objectives, whether it be on the side, bottom, shoulder or cap of the bottle.



Continuous Inkjet (CIJ)

- Integrates seamlessly into side grip conveyors for inline code verification applications
- Precise drop placement can create machine-readable 2D codes

Laser Marking Systems

- UV wavelength marks permanent, high resolution and high contrast codes onto HDPE/ LDPE
- 360° Arc Compensation software enables high quality marks on rotational devices, virtually eliminating distortion



Labels

Proven solutions to hit your mark windows

Label marking requires thoughtful integration to achieve effective placement and high quality. Videojet offers a wide array of printing technologies capable of label marking, and has dedicated experts to help you select the right technology for your application.

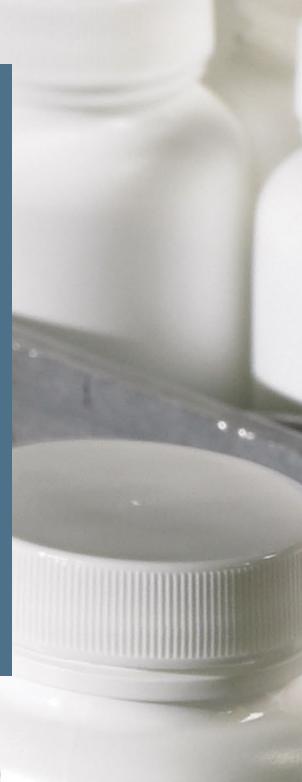
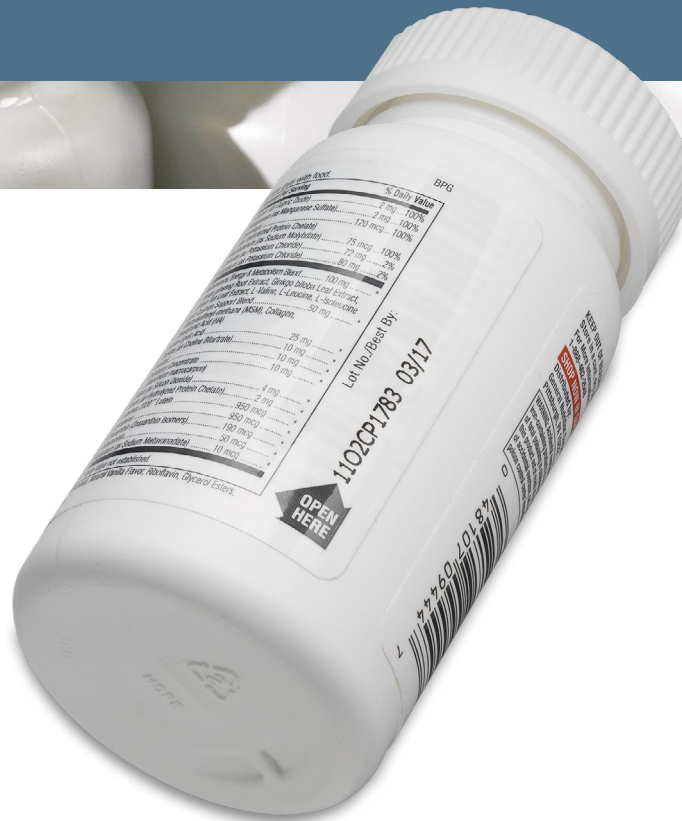



Thermal Transfer Overprinting (TTO)

- Simple, direct contact coding method for high resolution text and bar codes
- Configurable with a wide array of bracketry alternatives to integrate into the line prior to label application

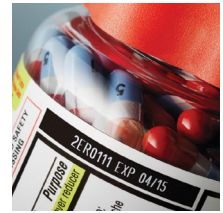



Thermal Inkjet (TIJ)

- No wear parts and simple cartridge changes help protect uptime
- Revolutionary Videojet 8610 printer features MEK-based inks to adhere to coated and plastic labels



Laser Marking Systems

- Ablates preprinted mark windows to create indelible, high-resolution coding
- Optimized software calculates most efficient path for marking, improving throughput



Continuous Inkjet (CIJ)

- Flexible umbilical and small printhead simplifies integration into labeling equipment
- With over 175 different inks, Videojet can partner with you to identify the ideal ink for your application

Flexible materials

Solutions for a wide variety of web-fed materials

From pouches to stick packs to Tyvek®, flexible materials are used to package a variety of pharmaceutical and medical device products. Integration into OEM equipment is often essential for reliable, high quality coding. Videojet works closely with leading equipment providers to develop solutions that perform well in web-based applications.

Thermal Transfer Overprinting (TTO)

- High resolution, wide format printing of alphanumeric, bar codes and single color icons
- Clutchless ribbon drive maintains optimal ribbon tension, virtually eliminating coder-related downtime



Thermal Inkjet (TIJ)

- Performs well on sterile medical packaging such as Tyvek®
- Configurable with up to 4 stacked printheads to code multiple packages on the web in a single pass

Continuous Inkjet (CIJ)

- Capable of coding on uneven surfaces, making it a strong solution for already formed flexible packages
- Ultra High Speed printers can create bold, font-like codes to improve legibility for consumers

Laser Marking Systems

- Laser coding flexible materials can produce both high-contrast and discrete codes, depending on the substrate
- With CO₂, UV and Fiber laser sources, Videojet is equipped to create the optimal code contrast for your product

Cases

Create traceability throughout the supply chain

Effective traceability only works with highly accurate, clearly readable information on your shipping cases. Many companies are implementing aggregation to track individual products through the distribution chain, requiring a coder than can work with machine vision solutions and packing equipment. The Videojet product range can address both your internal and external supply chain requirements.

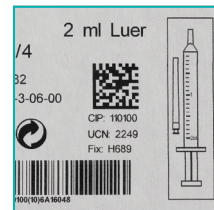

Thermal Inkjet (TIJ)

- Delivers high resolution DataMatrix and linear bar codes
- Compact printheads integrate easily into automated case packing equipment



Label Printer Applicator (LPA)

- Create GS1 bar code labels to meet distributor standards and facilitate aggregation
- Videojet 9550 direct applies labels immediately after printing, limiting errors in serialized applications



Large Character Marking (LCM)

- Print high resolution bar codes, logos and other information directly on cases
- Eliminates costs of labels or pre-printed cases where not precluded by local standards



Laser Marking Systems

- Laser marking a SunLase™ coated case produces a dark black, high resolution print
- Ideal for water-resistant coated boxes, as it enables printing without damage to the protective coating

Videojet solutions

Proven technologies to convey vital information

As pharmaceutical and medical device manufacturers, we understand you are faced with a great deal of complexity. Packaging materials span a wide range of substrates and coding requirements are driven by numerous local and regional regulations. Additionally, codes must contain a significant amount of content, often including a machine-readable DataMatrix code. One area you can simplify is with your coding provider. Our portfolio of innovative, tested solutions across a variety printing technologies uniquely positions Videojet to meet your needs.

Thermal Inkjet (TIJ)

Ideal for high quality text and bar codes on boxes, cartons, and cases ensuring that even complex and detailed codes are clearly readable for your downstream partners and consumers.



Laser Marking Systems

Improve the contrast and readability of your codes by permanently etching the material surface without physical contact or any need for solvents or extra supplies.



Continuous Inkjet (CIJ)

Most versatile of all variable technologies, combined with a portfolio of over 175 inks, CIJ prints on nearly any material and shape.



Thermal Transfer Overprinting (TTO)

Perfect for your flexible packaging applications, TTO gives you high quality codes and images, from date and time to DataMatrix codes and logos in a variety of colors.



Label Print Applicator (LPA)

When your customers require labels or you are using darker corrugated cases, LPA automatically applies labels to cases to help ensure high accuracy across a range of substrates.



Large Character Marking (LCM)

Eliminate pre-printed boxes and labels by printing your supply chain information directly to case, saving time and reducing costs.



Global Service offering

Broad service offering built with **you in mind**

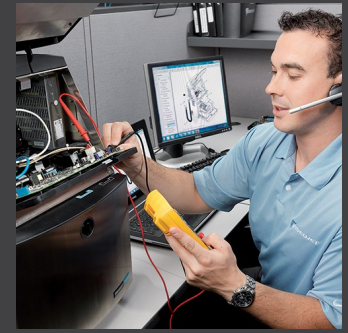

Start-up

The perfect introduction to peace of mind, ensuring a smooth transition during the adoption of new printers

Preventive

While your team focuses on production, our technicians safeguard your equipment with regular maintenance visits

Protective

For a team capable of general maintenance, take advantage of break & fix coverage plus wear parts replacement

Comprehensive

Let us take care of everything and enjoy 100% coverage to proactively optimize printer performance

	Start-up	Preventive	Protective	Comprehensive
24/7 technical phone support	●	●	●	●
Preventive maintenance	●	●		●
Break-fix coverage	●		●	●
Wear parts replacement			●	●
Priority service	●		●	●
Basic operator training	●			●
Consultative services and application support	●			●
Optional equipment leasing available			●	●

Further details of all Service Products can be found in our product specification sheets and any professional quotation supplied by Videojet.

You will benefit from:

Performance advantage

Properly maintained printers experience less downtime, last longer, and increase operator productivity. Rely on Videojet certified service technicians to maintain your coding equipment in peak operating condition.

Financial advantage

Service costs are predictable, protecting your budgets from expensive equipment failures while locking future services at current prices.

Service advantage

Customers get fast, prioritized, high-quality service from Videojet technicians. With the largest field service team in the industry, our trained experts are well positioned to respond quickly to your needs.

Peace of mind comes as standard

Videojet Technologies is a world-leader in the product identification market, providing in-line printing, coding, and marking products, application specific fluids, and product life cycle services.

Our goal is to partner with our customers in the consumer packaged goods, pharmaceutical, and industrial goods industries to improve their productivity, to protect and grow their brands, and to stay ahead of industry trends and regulations. With our customer application experts and technology leadership in Continuous Inkjet (CIJ), Thermal Inkjet (TIJ), Laser Marking, Thermal Transfer Overprinting (TTO), case coding and labeling, and wide array printing, Videojet has more than 325,000 printers installed worldwide.

Our customers rely on Videojet products to print on over ten billion products daily. Customer sales, application, service and training support is provided by direct operations with over 3,000 team members in 26 countries worldwide. In addition, Videojet's distribution network includes more than 400 distributors and OEMs, serving 135 countries.

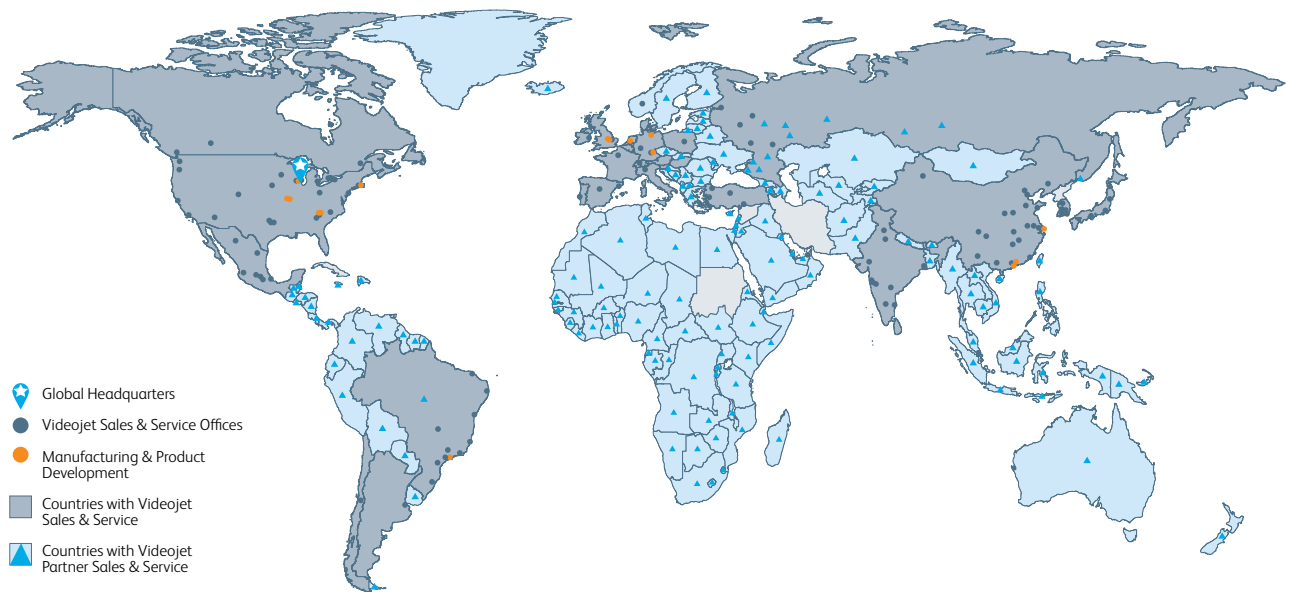

Call **+47 9041 8340**
Email **post.no@videojet.com**
or visit **www.videojet.no**

Videojet Technologies Norway
Kirkegårdsveien 45
3616 Kongsberg

© 2016 Videojet Technologies Inc. — All rights reserved.

Videojet Technologies Inc.'s policy is one of continued product improvement. We reserve the right to alter design and/or specifications without notice. TrueType is a trademark of Apple Inc., registered in the United States and other countries. DuPont is a trademark and Tyvek is a registered trademark of E. I. du Pont de Nemours and Company. SunLase is a trademark of Sun Chemical Corporation.

Part No. SL000520
br-pharmaceutical-and-medical-devices-en-no-0616

